

**READ ME !** ⚠

Thank you for purchasing a Dometic Hydration Water Jug 11L / 2.9Gal Rack Bracket.

Before you start, take a moment to familiarize yourself with the Fitting Instructions and the included components.

Refer to Page 2 for a list of all the components, quantities and tools required.

**IMPORTANT WARNING!** ⚠

IT IS CRITICAL THAT ALL FRONT RUNNER PRODUCTS BE PROPERLY AND SECURELY ASSEMBLED AND ATTACHED TO YOUR VEHICLE. IMPROPER ATTACHMENT COULD RESULT IN AN AUTOMOBILE ACCIDENT, AND COULD CAUSE SERIOUS BODILY INJURY OR DEATH. YOU ARE RESPONSIBLE FOR ASSEMBLING AND SECURING ALL FRONT RUNNER PRODUCTS TO YOUR VEHICLE, CHECKING THE ATTACHMENTS PRIOR TO USE, AND PERIODICALLY INSPECTING THE PRODUCTS FOR ADJUSTMENT, WEAR AND DAMAGE. THEREFORE, YOU MUST READ AND UNDERSTAND ALL OF THE INSTRUCTIONS AND PRECAUTIONS SUPPLIED WITH YOUR FRONT RUNNER PRODUCT PRIOR TO INSTALLATION OR USE. IF YOU DO NOT UNDERSTAND ALL OF THE INSTRUCTIONS AND CAUTIONS, OR IF YOU HAVE NO MECHANICAL EXPERIENCE AND ARE NOT THOROUGHLY FAMILIAR WITH THE INSTALLATION PROCEDURES, YOU SHOULD HAVE THE PRODUCT INSTALLED BY A PROFESSIONAL INSTALLER OR OTHER QUALIFIED PERSONNEL.

**NOTE:** Front Runner will not be responsible for any damage caused by the failure to install the product according to these instructions.

Please call us if you have any questions about the installation of this product.

# 1

## GET ORGANIZED

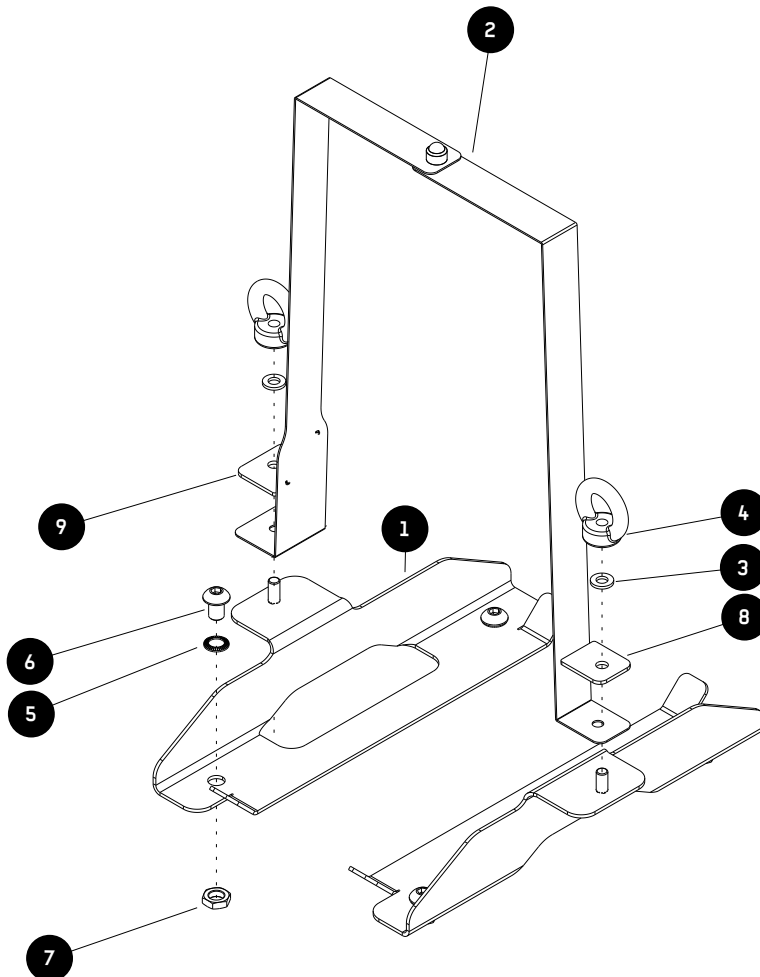
### IN THE BOX

1	2 X	Mounting Plate; 1 LH & 1 RH
2	1 X	Tank Strap
3	2 X	M6 Anti-loss Washer
4	2 X	M6 Eye Nut
5	4 X	M8 Schnorr Washer
6	4 X	M8 x 12 Button Head Bolt
7	4 X	M8 Thin Hex Nut
8	1 X	Clamp Plate
9	1 X	Clamp Plate Large

### TOOLS NEEDED

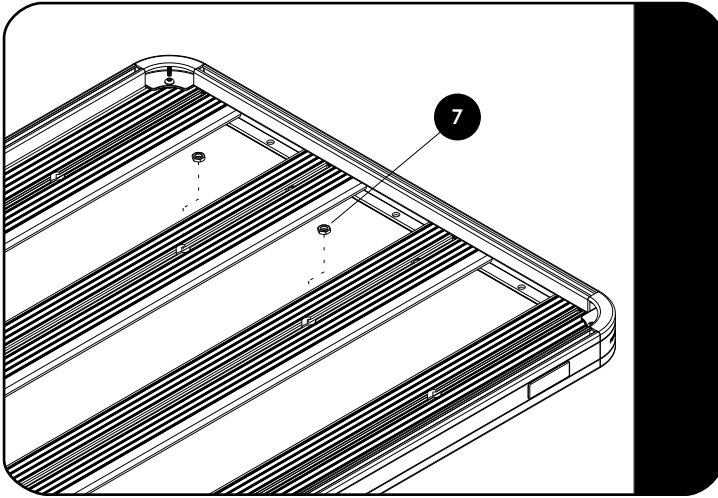


FIGURE 1.1



**2****FIT AND SECURE**

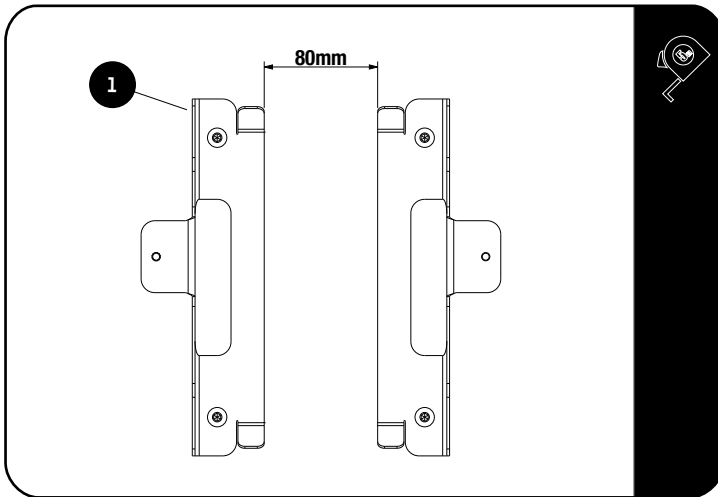
2.1



To fit the Rack Bracket Mounting Plates, start by choosing the position of the bracket on the Rack.

Load two M8 Thin Hex Nuts (Item 7) each into two slats as shown in fig 2.1.

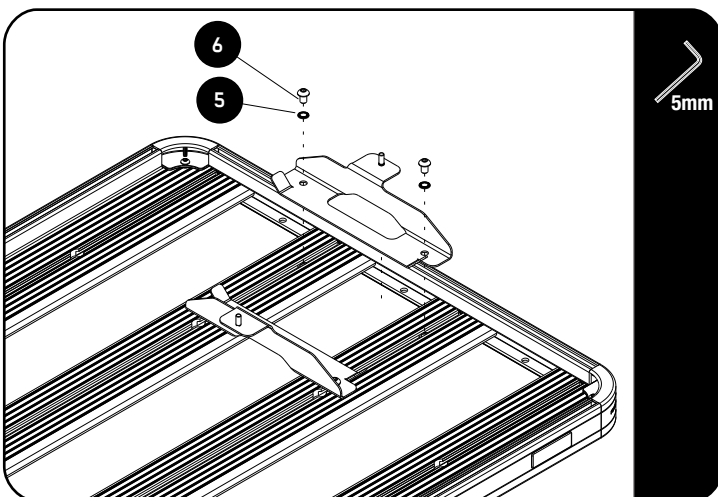
2.2



Place the Mounting Plates (Item 1) on the chosen slats 80mm apart.

Align the Thin Nuts placed in 2.1 with the mounting holes in the Mounting Plates.

2.3



Loosely assemble the each Mounting Plate using a M8 Schnorr Washer and M8 x 12 Button Head Bolt (Items 5 & 6).

Make final adjustments and tighten all fasteners.

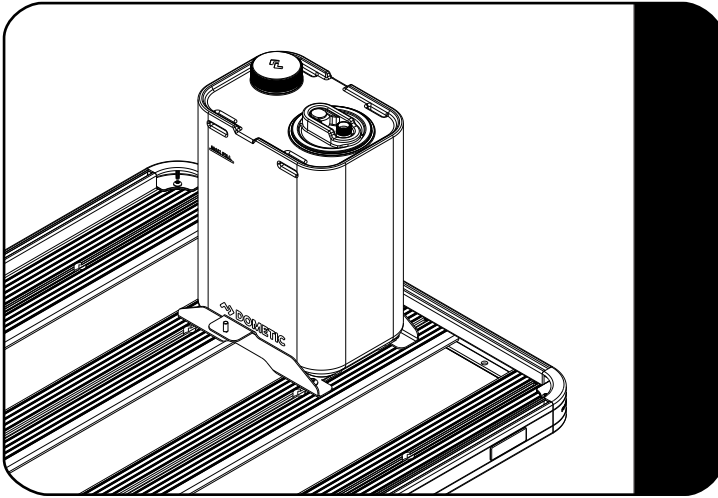
**Tightening Torque:**

M8 : 15-20Nm / 11.06 ft lb - 14.75 ft lb

2

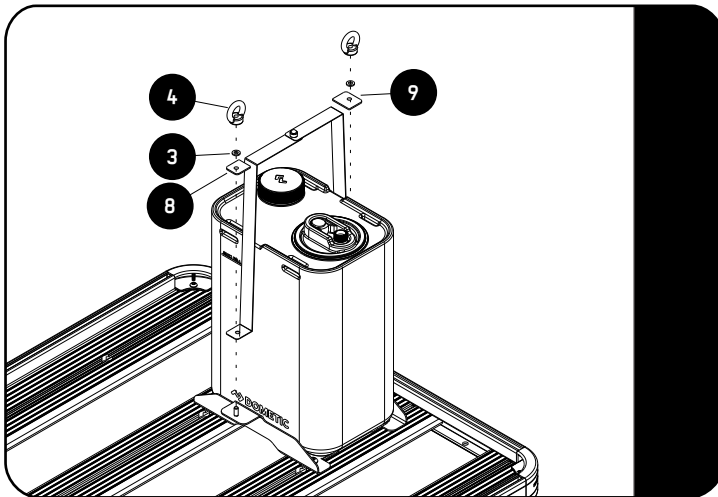
## FIT AND SECURE

2.4



Position the Dometic Hydration Water Jug on the Mounting Plates, making sure that it fits well between the Mounting Plates' sides and the bent up tabs.

2.5



Fit the Tank Strap over the tank in the slots on the top of the tank. The holes at the bottom of the strap should align with the studs in the Mounting Plates.



**Note:** Slots on the tank are off centre. If the tank strap holes do not line up with the studs, turn the tank and strap 180 degrees.

Fasten the tank strap to the Mounting Plates using a M6 Anti-loss Washer, Clamp Plate and M6 Eye Nut (Items 3, 8, 9 & 4).



**Note:** The Clamp Plate footprint should match the side of the strap it is installed on.



### Tightening Torque:

M8 : 15-20Nm / 11.06 ft lb - 14.75 ft lb

3

## FINISH

Congratulations! You did it. Take a step back and admire your work!

4

## INSTALL OTHER VEHICLE AND RACK ACCESSORIES

Now's the time to visit your favorite Front Runner Dealer in person or online.

Be sure to tag us. We love to see our gear in action! #FrontRunnerOutfitters #BornToRoam

Share your adventures on: 